

Product Data Sheet
Zone Control Valve Assembly
TUNPROTEC®
FIXED FIRE FIGHTING SYSTEMS
For road and rail tunnels

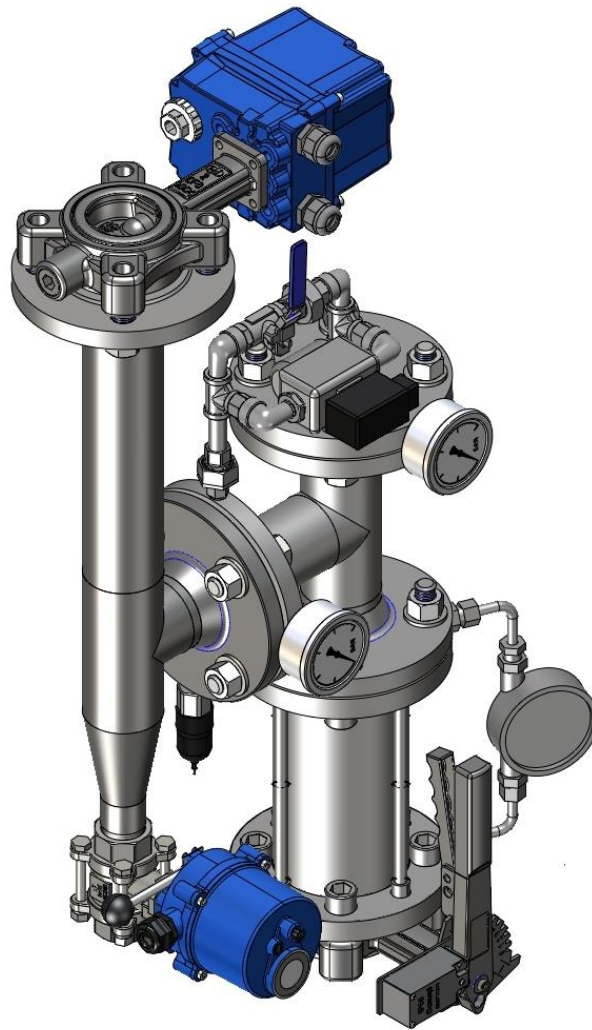

Description

The TUNPROTEC Model Tunprotec C-A-50-50i Zone Control Valve assembly is a factory-assembled and -tested fire zone control valve, designed for implementation in TUNPROTEC systems.

As fire zone control valve, the Model Tunprotec C-A-50-50i Zone Control Valve has been designed to hydraulically control the flow of water from the wet supply system to the dry TUNPROTEC N-Pipe low pressure water mist system.

The valve assembly includes:

1. Service Valve
2. Tamper switch (Service Valve position)
3. Zone control valve
4. DIN control box (optional)
5. Actuator for motorized drain valve
6. High-capacity filter
7. Actuator for motorized outlet
8. Service- and test valve Downstream
9. Pressure indicator
10. Solenoid Valve
11. Drain- and test valve

The Model Tunprotec C-A-50-50i features small outer dimensions, robust and reliable components, and the ability to remotely activate the zone control valve and to have it run a self-test sequence in which activation and alarm functions can be tested.

The fire zone control valve is shipped fully assembled and can be easily installed into protected areas or into cabinets.

Application

The Model Tunprotec C-A-50-50i Zone Control Valve had been designed and tested for installation in infrastructure tunnels of unlimited length. Among approved applications are road, train, metro, cable, conveyor, mining, and pedestrian tunnels.

Approvals

The zone control valve (3) has been approved with a *mean time to failure* (MTTF) of 150 years and is successfully component tested by FM Approvals.

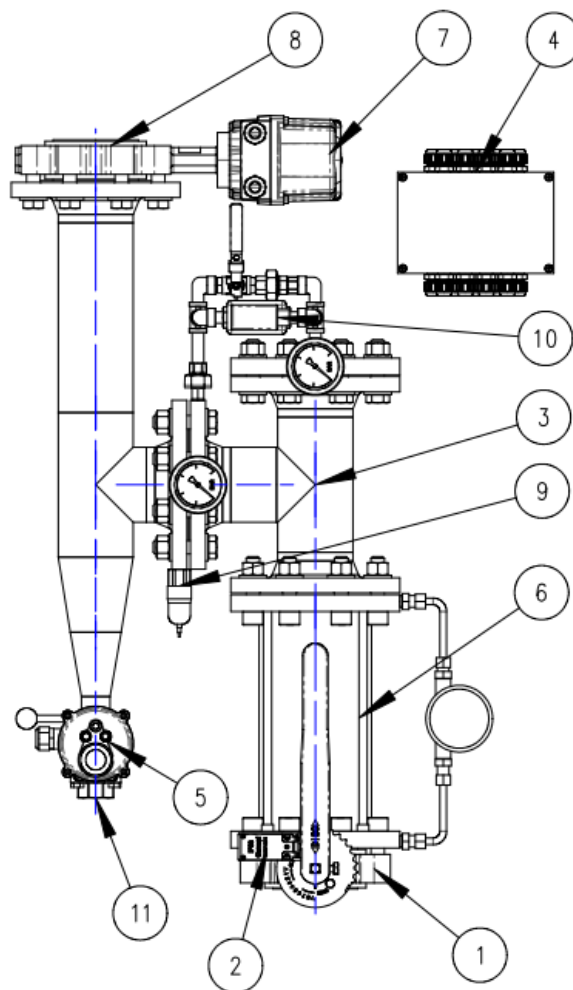

Technical data

General Description	
Dimensions:	890 x 570 x 295 mm (HxWxD)
Max. working pressure	25 bars
Kv-value	450 l/min/√(bar)
Material	AISI 316
Hydraulic connections	2x DN50 Flanged (In- / outlet) 1x 1" BSP (Drain)
Electrical components:	Solenoid valve: 12-24 VDC,
	Downstream service/test valve actuator: 12 - 24 VDC, 36W,
	Drain/test actuator: 12 - 24 VDC,
	Tamper Switch: 1NO+1NC,
	Pressure indicator: 42V, NO/NC,

The zone control valve can optionally be supplied with SIL 2 compliant activation.

Installation

Once received the Zone Control Valve shall be stored under safe conditions, protected from harmful materials and physical damage

Prior to installation of the Model Tunprotec C-A-50-50i Zone Control Valve, the pipe system to be connected shall be flushed and rinsed, and the area in which the valve assembly is to be installed into, shall be checked to not interfere with the valve assembly and its functions.

When installing Model Tunprotec C-A-50-50i Zone Control Valve, the valve assembly-

shall first be fixed in place using approved brackets or pipe-hangers and then connecting to the flanged inlet (1) and outlet (8) connections, after which the threaded drain connections can be connected to a general drain system and the control box (4) can be connected to detection and control systems.

Contact

For more information on the Model Tunprotec-C-A-50-50i, and the TUNPROTEC system and its components, kindly contact the TUNPROTEC sales team at tunprotec@vidfirekill.com

Dimensions

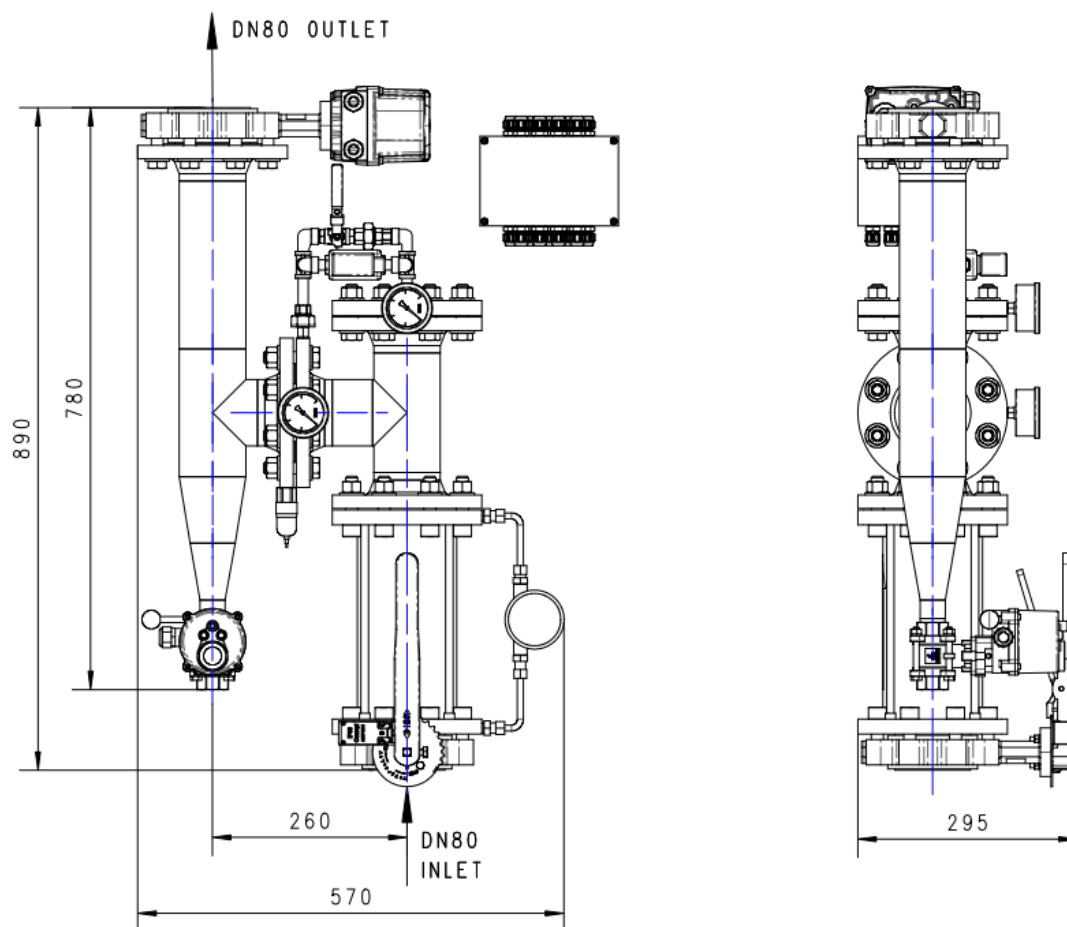

Disclaimer: VID Fire-Kill APS is not responsible for any errors or omissions, or for the results obtained from the use of this information. All information in this document is provided "as is", with no guarantee of completeness, accuracy, functionality, timeliness or of the results obtained from the use of this information.